



Operator's Manual

DWT135D4-550V Thruster

2T01-00001 24/01

DWTEK Co., Ltd

No.22, Dong Ying Rd., East District, Taichung City 401, TAIWAN

T: +886-4-3502-4890 | E: info@dwtek.com.tw

F: +886-4-2211-2890 | W: www.dwtekmarine.com

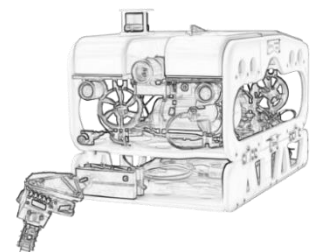



Revision information

Issue	Revisions	Date	Revised	Approver
1	First edition	2024/1/25	LIAO YU TSO	Mike Chen



Table of Contents

1	Introduction	6
1.1	General.....	6
1.2	Precautions	7
2	Specifications.....	8
2.1	Thruster	8
2.2	Connector.....	11
2.2.1	General.....	11
2.2.2	Indications for Replacement	11
2.2.3	Cleaning Procedure.....	11
3	Installation.....	12
3.1	Installation Guide.....	12
3.2	Pin Assignment	12
3.3	Maintenance and Removal.....	14
4	Trouble shooting	15
4.1	Thruster Trouble shooting	15
4.2	Detection Procedure.....	15
5	Maintenance	16
5.1	Nozzle	16
5.1.1	General.....	16
5.1.2	Indications for Replacement	16
5.1.3	Removal the Nozzle from Thruster	16
5.2	Propeller Assembly	17
5.2.1	General.....	17
5.2.2	Indications for Replacement	17
5.2.3	Removal Procedures	17
5.2.4	Install Procedures	17
5.3.1	General.....	18
5.3.2	Indication for Replacement.....	18
6	Oil Filled and Drain.....	25
7	Appendix.....	32
7.1	Vacuum and Pressure Relief	32
7.2	Spares and Tools.....	33
7.3	Exploded View.....	34



List of Figures

Figure 1 - DWT135D4 Thruster	8
Figure 2 - DWT135D4 Thruster performance curve	10
Figure 3 - DWT135D4 Thruster Pin Assignment	13
Figure 4 - Control Board Installation-1	18
Figure 5 - Control Board Installation-2	19
Figure 6 - Control Board Installation-3	19
Figure 7 - Control Board Installation-4	20
Figure 8 - Control Board Installation-5	20
Figure 9 - Control Board Installation-6	20
Figure 10 - Control Board Installation-7	21
Figure 11 - Control Board Installation-8.....	21
Figure 12 - Control Board Installation-9	21
Figure 13 - Control Board Installation-10	22
Figure 14 - Control Board Installation-11.....	22
Figure 15 - Control Board Installation-12	22
Figure 16 - Oil Filled-1	26
Figure 17 - Oil Filled-2	26
Figure 18 - Oil Filled-3	27
Figure 19 - Oil Filled-4.....	27
Figure 20 - Oil Filled-5.....	27
Figure 21 - Oil Filled-6.....	28
Figure 22 - Oil Filled-7.....	28
Figure 23 - Drain Oil-1	29
Figure 24 - Drain Oil-2	29
Figure 25 - Drain Oil-3	30
Figure 26 - Drain Oil-4	30
Figure 27 - Drain Oil-5	31
Figure 28 - DWT135D4 Thruster (2B0040009-00001).....	34
Figure 29 - Housing Assy (2C004-00050).....	35
Figure 30 - Flat Box Assy (2C004-00055)	36
Figure 31 - Compensation Module (2C004-00057).....	37



List of Tables

Table 1 - Precautions.....	7
Table 2 - DWT135D4 Specification	9
Table 3 - DWT135D4 Thruster Electrical.....	12
Table 4 - Pin Assignment	12
Table 5 - Driver Board	23
Table 6 - Control Board	23
Table 7 - Capacitor Board	24
Table 8 - Spares list.....	33
Table 9 - Tools list.....	33



1 Introduction







1.1 General

DWTEK releases new range of brushless DC thrusters with the outstanding characters of low-weight, powerful thrust and integral electronic components. The engineering capabilities of DWTEK in subsea application drive our passion to innovate high reliable design and components to our thrusters.

DWT135D4 thruster is a heavy-duty electric underwater thruster. The design is in purpose of high efficiency and low noise stealth; meanwhile it is suitable the propulsion system of any underwater robots or high-end surface utility vehicles.

1.2 Precautions

Table 1 - Precautions

	<p>The “DANGER” symbol indicates a hazardous situation which, if not avoided, will result in death or serious injury. Carefully read the message that follows to prevent serious injury or death.</p>
	<p>The “WARNING” symbol indicates a hazardous situation which, if not avoided, could result in death or serious injury. Carefully read the message that follows to prevent serious injury or death.</p>
	<p>The “CAUTION” symbol indicates a hazardous situation which, if not avoided, could result in minor or moderate injury, or equipment damage. Carefully read the message that follows to prevent minor or moderate injury.</p>
	<p>The “NOTICE” symbol alerts to a situation that is not related to personal injury but may cause equipment damage</p>
	<p>Do not put hands near it when machine operating.</p>
	<p>Do not wear electrically conductive jewelry, clothing, or other items while working on the electrical system.</p>
	<p>An electric shock could be fatal. Ensure power to the Thruster is OFF” before opening electrical panels.</p>

2 Specifications

2.1 Thruster

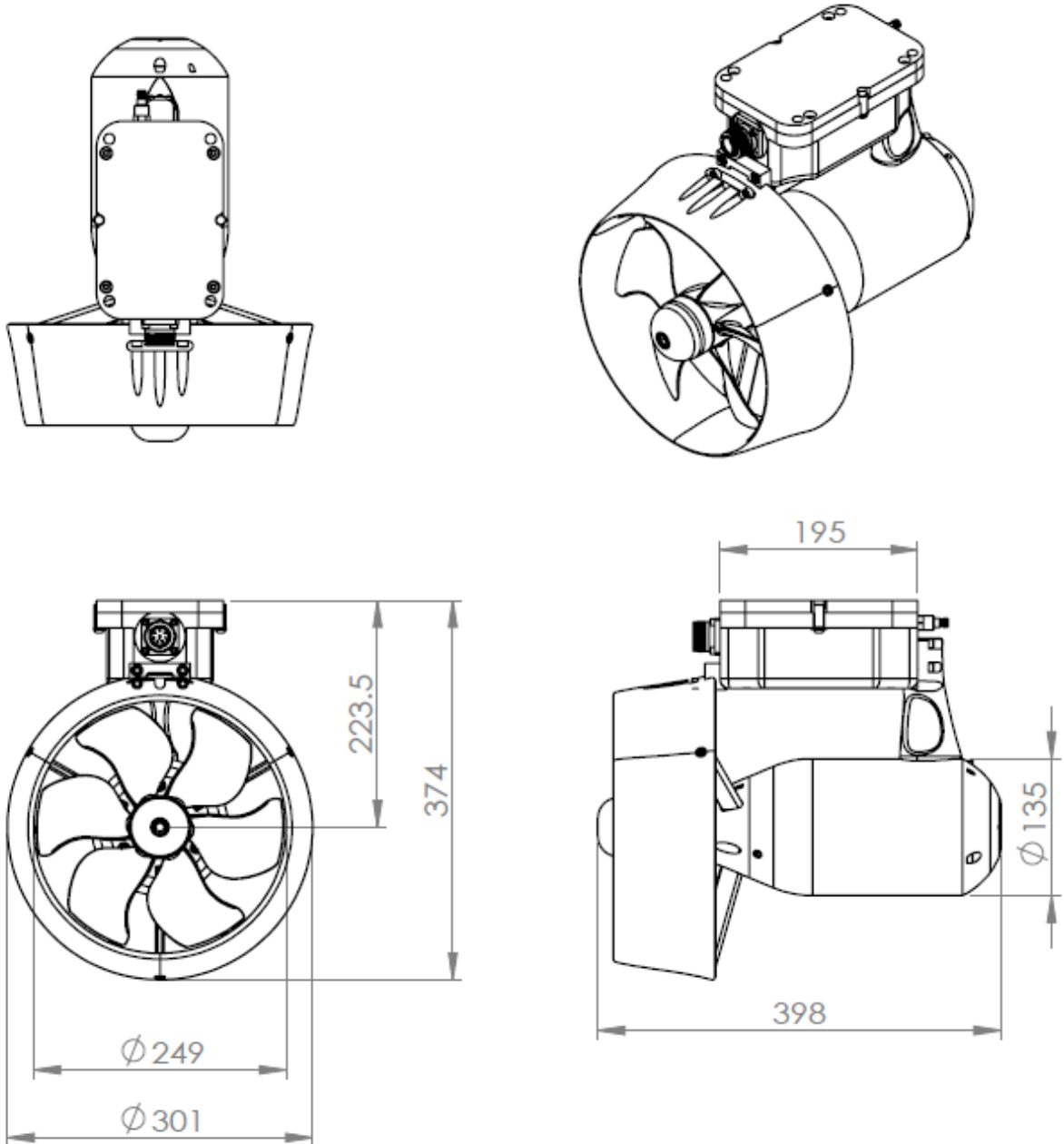

Figure 1 - DWT135D4 Thruster



Table 2 - DWT135D4 Specification

DWT135D4	
MECHANICAL	
Weight in air	17.8 kg
Weight in water	10.3 kg
Standard Housing	AL 6061-T6
Propeller	Engineering Plastic
Nozzle	Nylon
ELECTRICAL	
Operation Voltage	550 VDC
Speed Control	±5V
Drive	Direct Drive
Watt	5000W
Protection	Over-Temp / Over Current / Under Voltage / Abnormal Operation
PERFORMANCE	
Thrust	CW: 95 kgf / CCW: 85 kgf

DWT135D4-550V THRUST PERFORMANCE CURVES

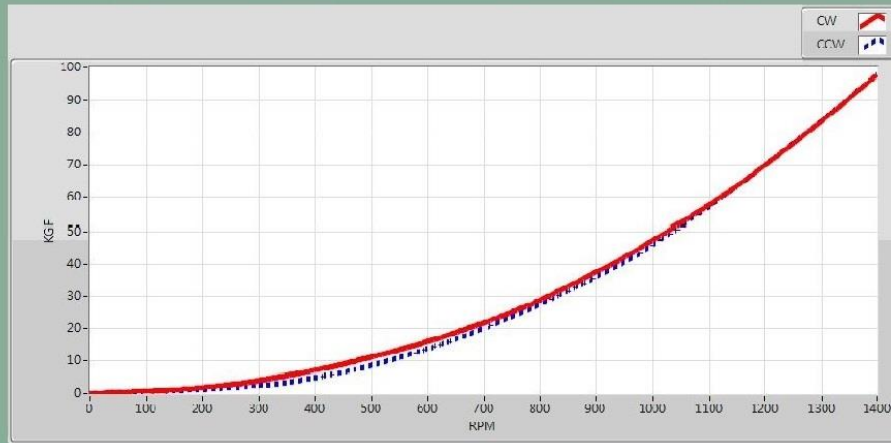

RPM VS KGF

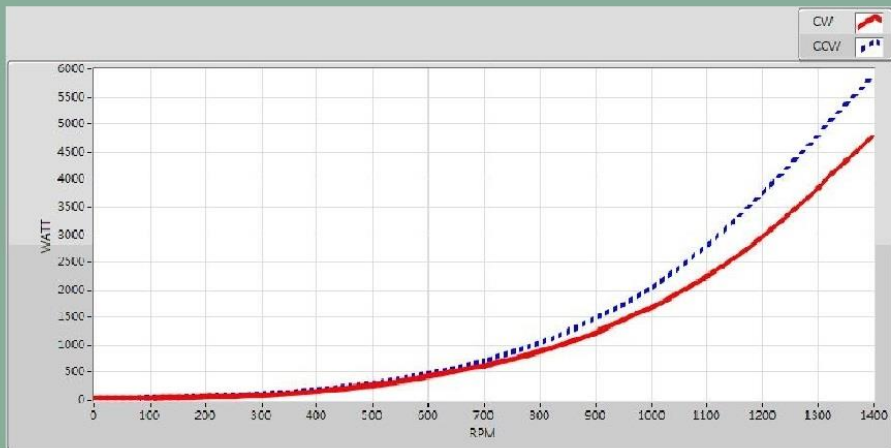

RPM VS WATT

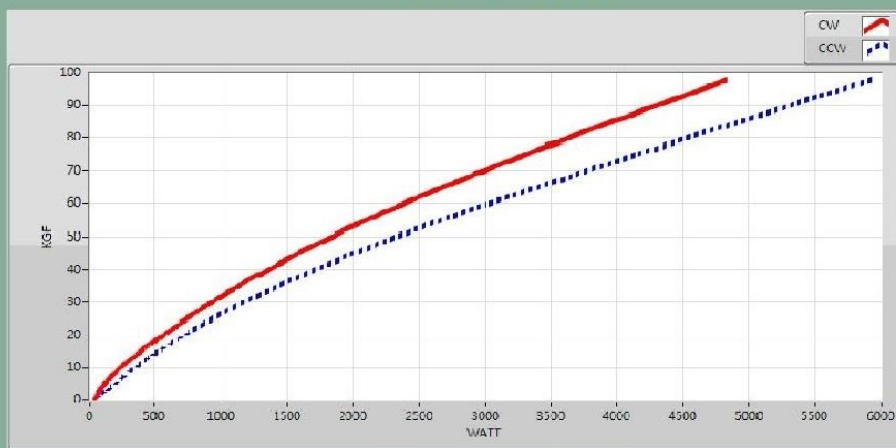

WATT VS KGF

Figure 2 - DWT135D4 Thruster performance curve



2.2 Connector

2.2.1 General

Part No.	2GM170708M-00002
Title	Metal Shell L Flange Connector Male 8 Pin
Service Check	Regularly

2.2.2 Indications for Replacement

Replace if connector is damaged, deformed or no longer watertight.

2.2.3 Cleaning Procedure

General cleaning and removal of any accumulated sand or mud on a connector should be performed with spray based contact cleaner, Isopropyl Alcohol.



Warning!!

Only the qualified specialist is allowed to proceed the connector replacement.

3 Installation

3.1 Installation Guide

Table 3 - DWT135D4 Thruster Electrical

	Nominal	Max	Min
Input Voltage	550 VDC	600 VDC	500 VDC
Input Current	9.1A	8.33A	10A
Instrument Power Voltage	15V	16.5V	13.5V
Instrument Power Current	0.18A	0.16A	0.2A
Analog	+/- 5V	+/- 6V	

Procedure of electronic Connection:

- Step1. Connect Pin3 to +550 VDC
- Step2. Connect Pin1 to HGnd
- Step3. Connect Pin5 to +/- 5V Signal
- Step4. Connect Pin7 to +/- 5V ISO GND
- Step5. Connect Pin4 to +15 VDC (instrument)
- Step6. Connect Pin1 to HGnd (instrument 15 VDC)
- Step7. Connect Pin2 to Protection Earth point where available

3.2 Pin Assignment

Table 4 - Pin Assignment

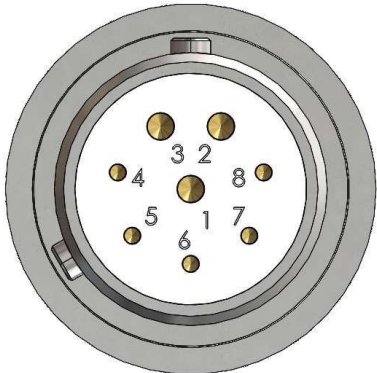
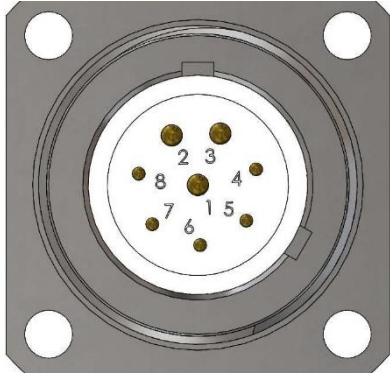
Female Inline Top View	Pin Assignment	Male Bulkhead Top View
	1 : HGnd 2 : PE 3 : +550 VDC 4 : +15 VDC 5 : +/- 5V 6 : N/A 7 : ISO GND 8 : N/A	

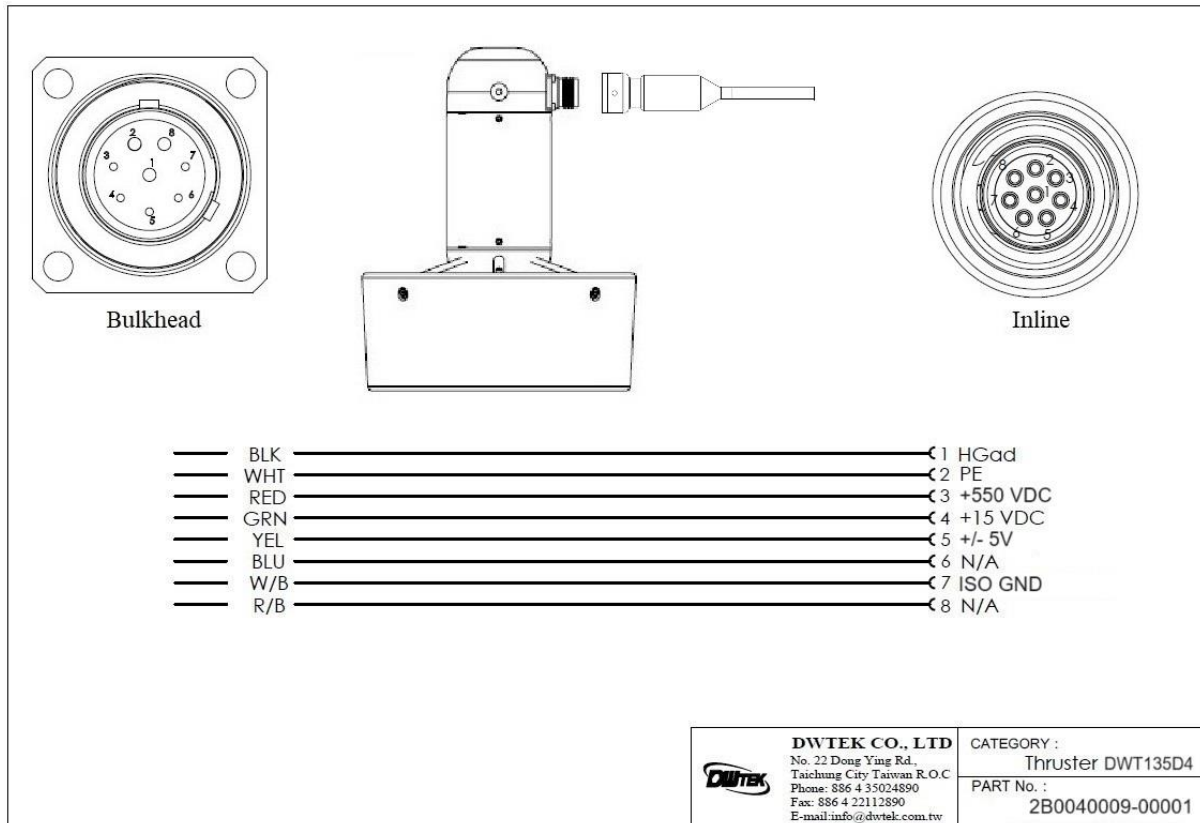

Figure 3 - DWT135D4 Thruster Pin Assignment

Make sure all the connections are correct, and follow the instruction listed as below to power the thruster.

1. Connect Pin2 to the Protection Earth point
2. Deliver +15 VDC to Pin4 and Pin1
3. Deliver +/- 5V control signal to Pin5 and Pin7
4. Make sure +/- 5V control signal is set within +/- 0.2 VDC
5. Deliver +550 VDC to Pin3 and Pin1
6. Adjust +/- 5V control signal to Pin5 and Pin7
7. Thruster should turn CW and CCW based on the apply voltage polarity

Note!!



1. Control signal is set as 0 RPM within +/- 0.2VDC.
2. Always make sure to set the control signal within +/- 0.2VDC before powering on 550Vdc to the thruster. Failure to do so would result in the thruster not being activated because of the safety startup procedure.
3. The WATT of DWT135D4 at the maximum speed is about 5000W±5%.
4. After the thruster powers on, DO NOT REMOVE the control +/- 5V, otherwise the speed will be abnormal.



3.3 Maintenance and Removal

To remove the thruster, please follow below steps.

1. Disconnect the cable.
2. Install the protection dummy on the bulkhead connector

THRUSTER FIELD & DEPOT REPAIR PROCEDURES LISTED BELOW SHALL BE CARED.



Warning!!

Make sure to switch off thruster power and auto-functions once the system is on the surface.



Caution!!

It recommends considering the replacement of the O-rings and resealing DWT 1 thruster as annual maintenance. DWTEK offers comprehensive annual inspection and maintenance service to guarantee reliability and performance.



Caution!!

The thruster is designed as a simple maintenance unit. After each dive, please always wash with fresh water.

4 Trouble shooting

4.1 Thruster Trouble shooting

If thruster performed:

- I. RPM unsteady.
- II. Vibration.

please proceed the initial detection procedure which mainly caused by two type of cases as below:

- I. Power output.
- II. Consumption parts and determine the replacement.

4.2 Detection Procedure

1. Make sure the propeller is free of rotation and under safety and well protection.
2. Apply +15 VDC to Pin4 and HGnd to Pin1. It recommends using power supply with the current consumption indicator. The nominal current consumption is 0.18Amp +/- 0.02.
If current consumption is out of the above range without loading, the control PCB need to be examined and replaced.
3. Measure the analog input +/- 5V with multimeter and make sure +/- 5V is connected to Pin5 and Pin7 ISO GND.
4. Apply input voltage +550 VDC to Pin3 and HGnd to Pin1.
5. Make sure +/- 5V signal is within +/- 0.2V before delivering +550 VDC to thruster.
6. Use a current indicator to wire on the power supply in series before delivering +550 VDC.
7. Make sure current output is less than 0.1A when signal is 0V.



Caution!!

If the current goes higher with short circuit, the power PCB need to be examined and replaced, please do not hesitate to contact DWTEK Co., Ltd.



5 Maintenance

5.1 Nozzle

5.1.1 General

Part No.	2D004-00070
Title	Nozzle
Service Check	Replace if damaged
Tool	4mm Allen Key

The nozzle is designed to improve the performance in water. Without the nozzle, there would be a drastic thrust reduction and control failure. Thruster can be tested in air but it recommends contacting DWTEK if doing enforced dummy load in the shaft of thruster.

The nozzle consists of a cast Nylon material that is high impact-resistant.

5.1.2 Indications for Replacement

Please replace the nozzle if it damages to the point that it fouls the propeller.

5.1.3 Removal the Nozzle from Thruster

1. Remove (3) SS Socket Head Cap Screw M5x115mm (P/N 2D013-00015) with 4mm Allen Key.
2. Remove (3) Support Rod (P/N 2D004-00074) in the Nozzle.

Installation Procedures

1. Install (3) Support Rod (P/N 2D004-00074). Make sure to align the hole in the Nozzle.
2. Put (3) SS Socket Head Cap Screw M5x115mm (P/N 2D013-00015) into Nozzle through Support Rod.
3. Secure screws with 4mm Allen Key(4.2NM).



NOTE!!

If you have any further queries, please do not hesitate to contact DWTEK Co., Ltd.

5.2 Propeller Assembly

5.2.1 General

Part No. :	2P005-SET0090
Title :	Vectus Propeller
Service Check :	Before and after each dive
Tool	1. Screw Driver 2. 8mm Allen Key

DWT135D4 thruster uses Vectus propeller that has outstanding thrust performance in operation.

5.2.2 Indications for Replacement

Replace it if significant wear or damage is apparent on the blades of the propeller.

5.2.3 Removal Procedures

1. Unscrew SS Socket Head Cap Screw M10x40mm (P/N 2P001-D1B2M10-15040) with 8mm Allen Key.
2. Remove Propeller Hub (P/N 2D004-00094) and Vetus Propeller (P/N 2P005-SET0090) from the shaft.

5.2.4 Install Procedures

1. Insert SS Parallel Key 6 x 6 x 40mm (P/N 2P001-K322M6-6-40) into Shaft
2. Install Vetus Propeller (P/N 2P005-SET0090) onto shaft and confirm Pin touch on the Propeller groove.
3. Install Propeller Hub (P/N 2D004-00094) and secure SS Socket Head Cap Screw M10x40mm (P/N 2P001-D1B2M10-15040) with 8mm Allen Key(34NM).



Warning!!

Operator is only allowed to remove propeller assembly under power off condition.



NOTE!!

If you have any further queries, please do not hesitate to contact DWTEK Co., Ltd.

5.3 Motor Driver

5.3.1 General

Part No. :	2N004-00008
Title :	5000W PCB
Service Check :	Damaged 、 malfunction
Tool :	1. Screw Driver 2. Multimeter

DWT135D4 Motor Driver (P/N 2N004-00009) is mounted in flat box Assy (P/N 2C004- 00055) along with a capacitor connection board. It is a high-performance, modularized motor driver with the compact design. It's critical to cool the motor driver during the operation. DWTEK only recommends operating thruster in water. Applying load to the thruster in the air should be consulted with DWTEK in advanced for further information.

5.3.2 Indication for Replacement

Replace the motor driver board if the thruster does not work smoothly or malfunction. Make sure the all three capacitors are connected.

If there is any failure or unknown problems occurred, please contact DWTEK or the authorized agent for service.

5.3.3 Control Board Installation

1. Cut the heat sink patch into size and laid as shown on the picture



Figure 4 - Control Board Installation-1

- Solder the wires onto the driver board

※15V : Green Wire

HGND : Black Wire

HV : Red Wire

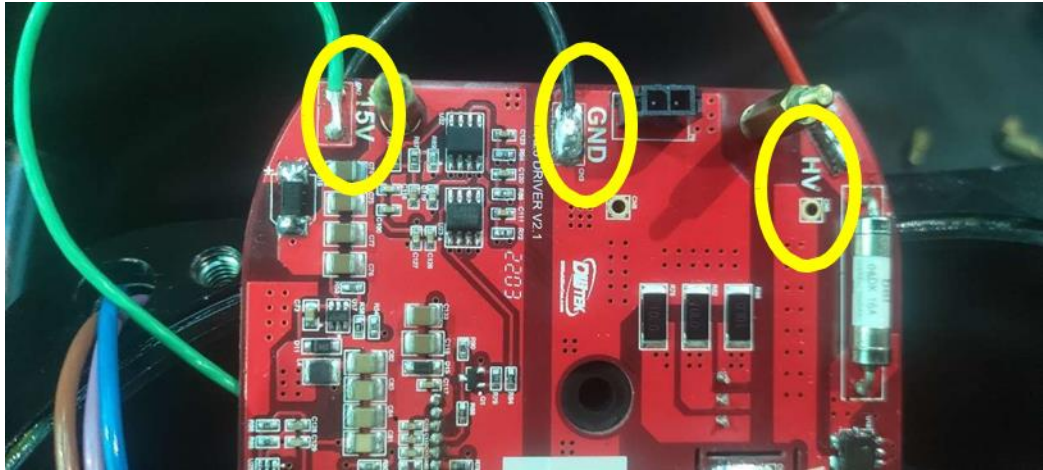

Figure 5 - Control Board Installation-2

- Route the wires underneath the PCB and secure the PCB with (2) M4*10 mm screw.

Note: Wires should be clear with the Drive module.

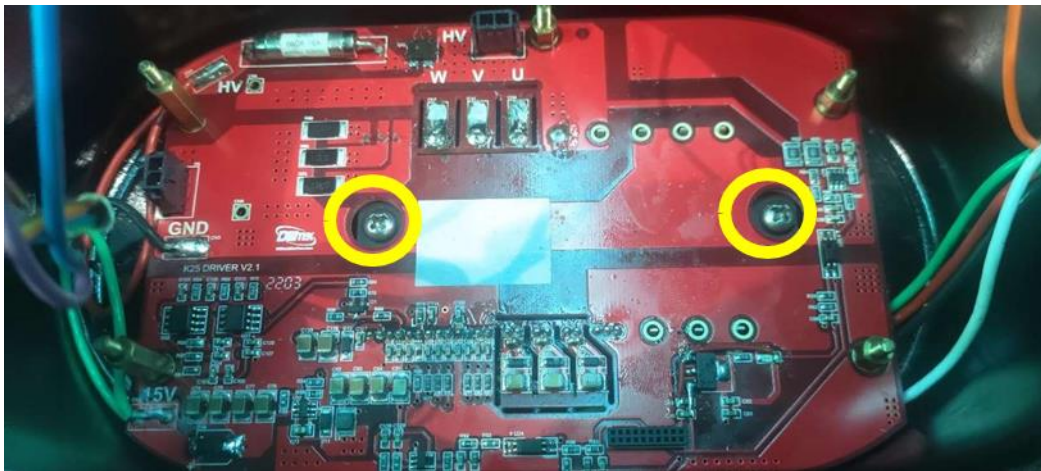

Figure 6 - Control Board Installation-3

4. Solder U、V、W wire to Driver Board

U : Blue Wire

V : Brown Wire

W : Purple Wire

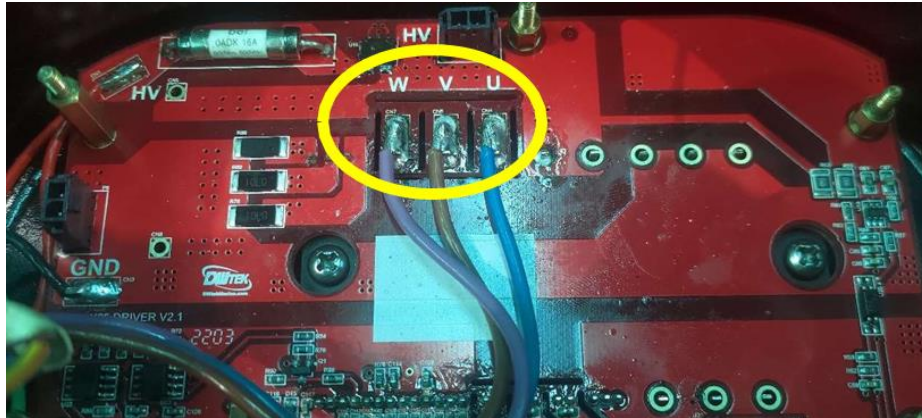

Figure 7 - Control Board Installation-4

5. Install control board to driver board

Align the connectors before push control board into place.



Figure 8 - Control Board Installation-5

6. Apply Loctite 243 on the copper pillars

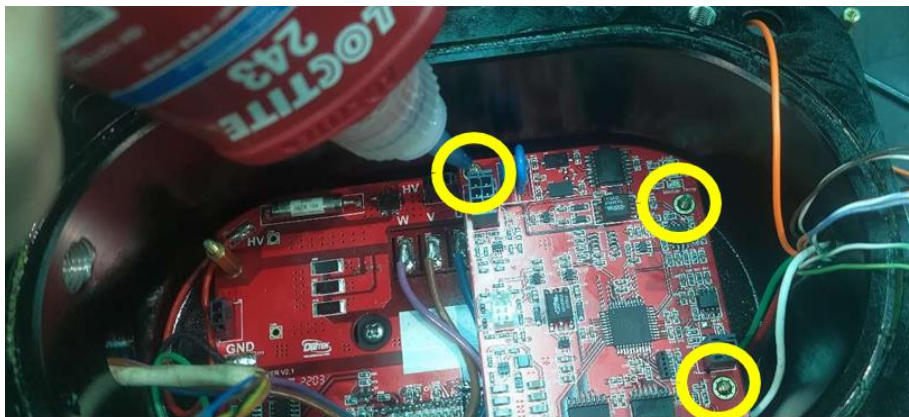

Figure 9 - Control Board Installation-6

7. Secure with copper pillars and a nut

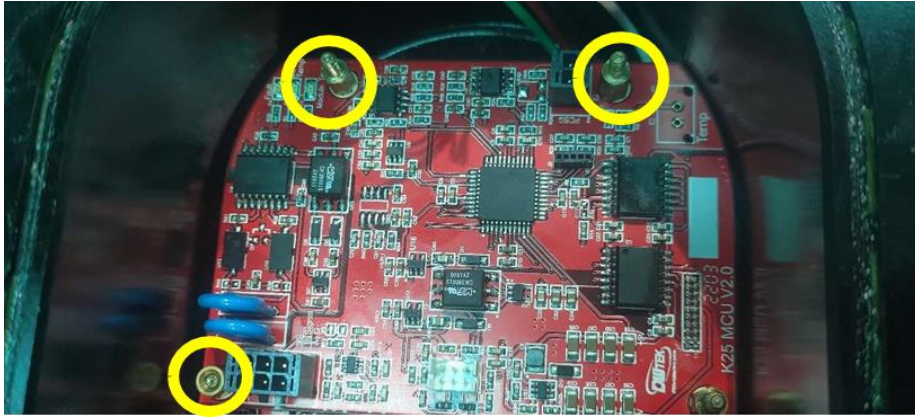

Figure 10 - Control Board Installation-7

8. Align the capacitor board with 5 copper pillars and apply Loctite 243.



Figure 11 - Control Board Installation-8

9. Secure with nuts



Figure 12 - Control Board Installation-9

10. Connect hall cable connector and control cable connector (+/-5V)
11. ※Hall Cable : Red/Green/Brown/Yellow/Orange
Control Cable(+/-5V) : Orange/Black & White

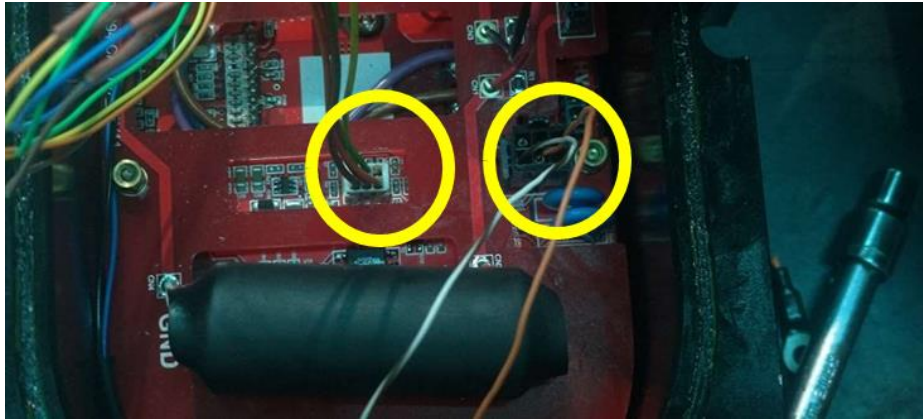

Figure 13 - Control Board Installation-10

12. Connect capacitor board and driver board HV and GND connectors
※HV : Red Wire
HGND : Black Wire

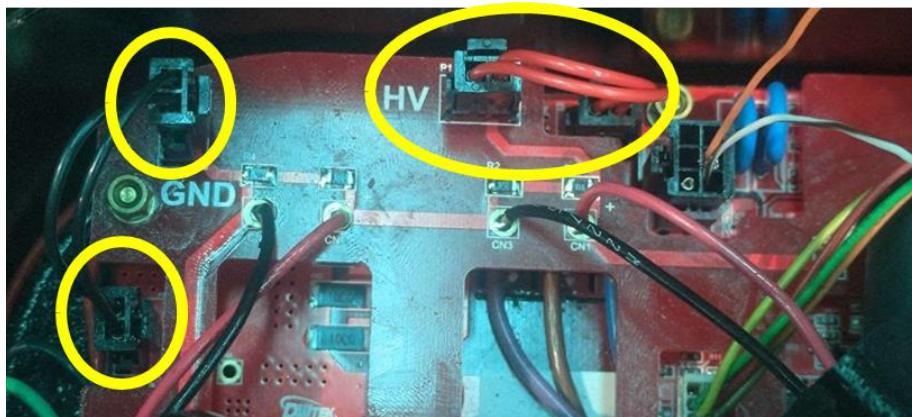

Figure 14 - Control Board Installation-11

13. Lay the capacitor pod in order and tidy up the wires

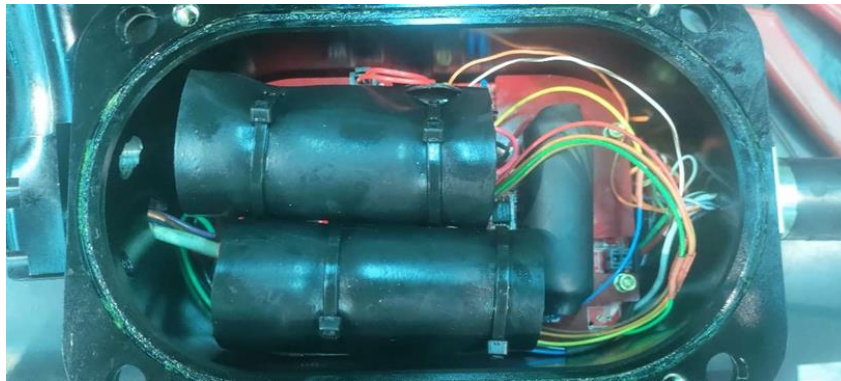

Figure 15 - Control Board Installation-12

5.3.4 PCB Connection and Definition



Table 5 - Driver Board

	Connector	No. of Pins	Pin Assignment	Function	Type	Color code
Driver Board	CN1	1	1	HV	Pad	Red
	CN2	1	1	+15V	Pad	Green
	CN3	1	1	GND	Pad	Black
	P5	2	1	HV	Molex Fit3.0 1x2 66200211122 + + Red Red To Cap Board P1	Red
			2			Red
	P6	2	1	GND	Molex Fit3.0 1x2 66200211122 - - Black Black To Cap Board P2	Black
			2			Black
	CN4	1	1	U	Pad	Blue
	CN5	1	1	V	Pad	Brown
CN6	1	1	W	Pad	Purple	

Table 6 - Control Board

	Connector	No. of Pins	Pin Assignment	Function	Type	Color Code
Control Board	P3	6	1	RS485-A	Molex Fit3.0 2x3 66200621122 A B SG N/A N/A N/A IG Signal Black/White Orange N/A	N/A
			2	RS485-B		N/A
			3	Signal GND		N/A
			4	ISO-GND		Black/White
			5	+5V		Orange
			6	N/A		N/A
	P2	6	1	VCC	WAFER 2.0 2x3 VCC GND HA HB HC Yellow Green Brown Orange Red	Yellow
			2	GND		Green
			3	N/A		N/A
			4	Hall A		Brown
			5	Hall B		Orange
			6	Hall C		Red

Table 7 - Capacitor Board

	Connector	No. of Pins	Pin Assignment	Function	Type	Color Code
Capacitor Board	P1	2	1	HV	Molex Fit3.0 1x2 66200211122 	Red
			2	HV		Red
	P2	2	1	GND	Molex Fit3.0 1x2 66200211122 	Black
			2	GND		Black



Warning!!

Operator is only allowed to remove Motor Driver assembly under power off condition.



NOTE!!

If you have any further queries, please do not hesitate to contact DWTEK Co., Ltd.



6 Oil Filled and Drain

DWT135D4 Thruster needs to be oil filled in order to cool the high-performance electric devices and increase the reliability of thruster for underwater operation. The oil-filled and drain operation may involve few skills and concepts. If anything in doubt, please feel free to contact manufacturer for instruction.

Warning!!

Morlina S2 BL or equivalent - Avoid prolonged and repeated touch with skin.



If swallowed, call a poison Control Centre or doctor immediately. Please contact the Oil manufacturer or distributor to request Safety Data Sheet and always read the Safety Data Sheet before operation.

6.1 Oil Filled

1. Always make sure the thruster is fully assembled and sealed before oil filling.
2. Use M4 Allen key to remove the vacuum plugs both on motor housing and flat box Assy housing.



Figure 16 - Oil Filled-1

3. Fill up the pressurized filler bottle with Morlina S2 BL 10 and free the air from the hose.



Figure 17 - Oil Filled-2

4. Connect the quick connector into the male connector on the flat box assy.

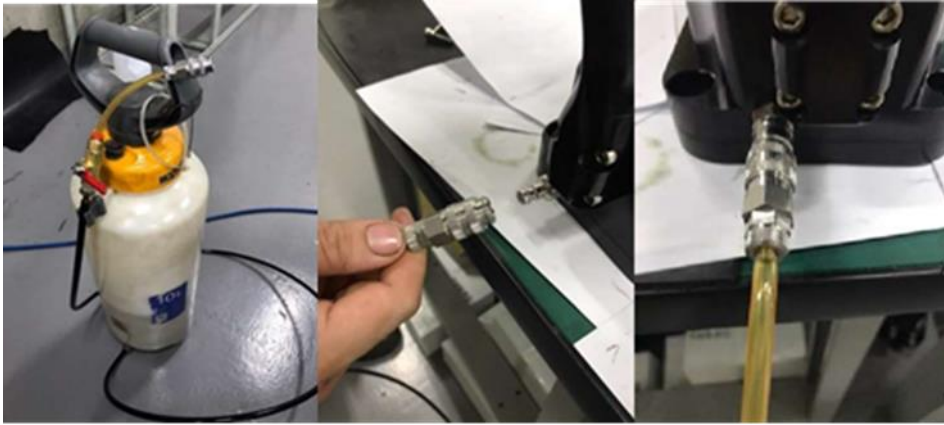

Figure 18 - Oil Filled-3

5. Start to pump oil into flat box assy.

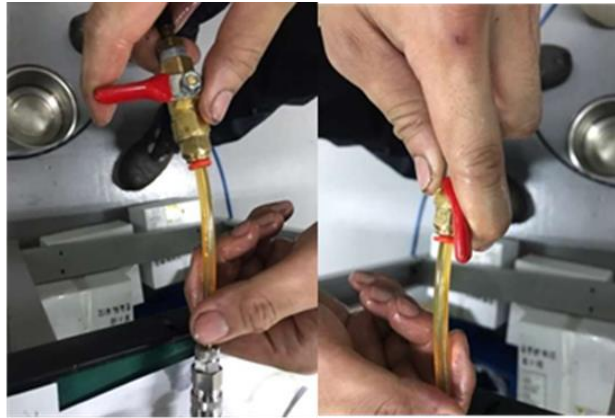

Figure 19 - Oil Filled-4

6. When oil reaches the level of the flat box Assy vacuum hole. Stop pumping oil into the flat box assy.

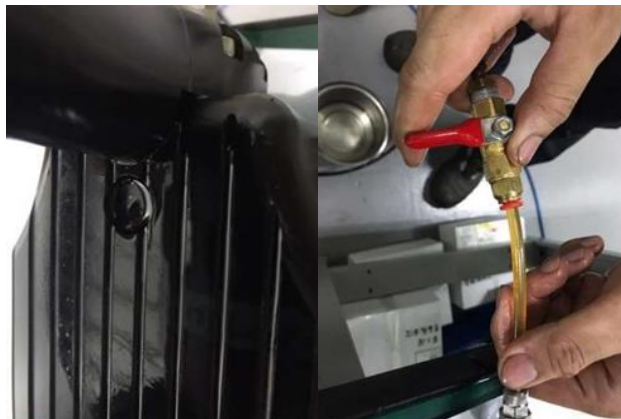

Figure 20 - Oil Filled-5

7. Use M4 Allen key to tight the vacuum bolt back to the flat box Assy (2.1NM). Be aware that the O-ring should be fitted properly on the vacuum bolt.



Figure 21 - Oil Filled-6

8. After the vacuum bolt has been sealed, pump oil into the flat box assy. Tilt up/down and rotate the propeller to free the air from trapping inside the motor housing.
9. Repeat step 8. Stop pumping oil into the flat box Assy once the oil overflows from the vacuum hole on the motor housing.
10. Make sure the End Cap screw touch the End cap.



Figure 22 - Oil Filled-7



Warning!!

The operator is required to wear the protection gloves and glasses before starting the oil-filling operation.

6.2 Drain Oil Procedure

1. Connect the female quick connector to the male one on thruster flat box assy.

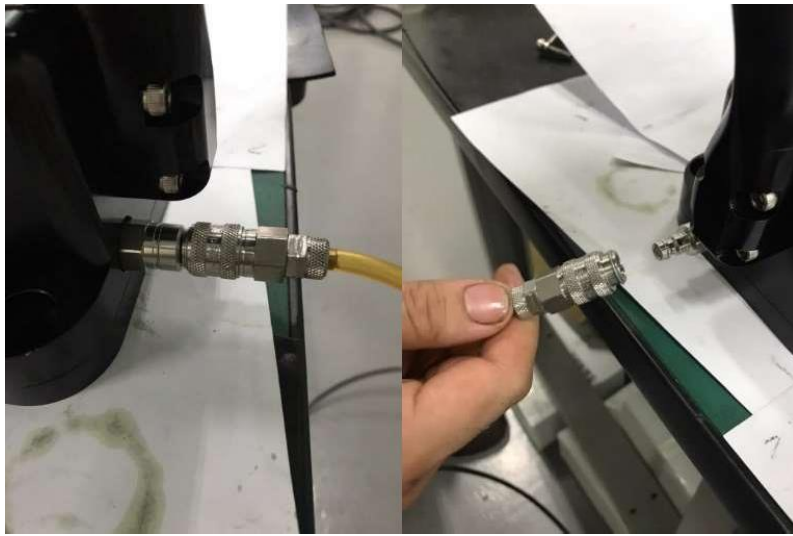

Figure 23 - Drain Oil-1

2. Prepare a container to keep the oil.



Figure 24 - Drain Oil-2

3. Use M4 Allen key to remove the vacuum bolt on motor housing. The oil would be draining out right after removing the vacuum bolt.



Figure 25 - Drain Oil-3

4. After the oil drains away slowly, use M4 Allen key to remove the vacuum bolt on flat box assy.



Figure 26 - Drain Oil-4

5. Wait till the oil stop draining, unplug the QD from flat box assy



Figure 27 - Drain Oil-5



Caution!!

Visible inspection to electric driver and make sure no burned mark, loose/disconnected wire or damage. If any, please contact manufacturer.



Caution!!

Dispose polluted oil according to local regulations and protect the environment responsibly.

7 Appendix

7.1 Vacuum and Pressure Relief

All electronic components could generate heat and prohibit system operation with a vacuum condition. Pressure relief port can be used as a vacuum port for testing purpose.

Recommended vacuum test on the pod is -80kPa for a period of 30 to 60 minutes after disassemble and re-assembly. It should be released once the testing is complete. Filling in Nitrogen gas from the Nitrogen bottle with an adaptor would take out the moisture to prevent concentration.

Warning!!



- 1. Make sure that this process was carried out in a well-organized place.**
- 2. Check and clean the O-rings on pressure relief valve before installation. If they are damaged, please replace it with new one, and greased with Silicone Grease.**



7.2 Spares and Tools

Table 8 - Spares list

Item No.	Part No.	Description	Qty
1	2P002-SOR-AS012N70	O-Ring ID9.25 x W1.78	2pcs
2	2D003-00016	Pressure relief valve 5/16"xT24	2pcs
3	2P002-SOR-AS163N70	O-Ring ID152.7 x W2.62	1pcs
4	2P001-D1B2M4-07016	Socket Head CAP Screw SUS316 M4xP0.7x16	4pcs
5	2P001-WW5526	Wave Washer WW-26 (26.4x34.2x3.5t)	1pcs

Table 9 - Tools list

Item No.	Part No.	Description	Qty
1	2J07-00002	Syringe + Silicone Grease set	1pcs
2	2P001-FLU5M4	M4 Allen Key	1pcs

7.3 Exploded View

ITEM No.	PART No.	TITLE	DESCRIPTION	QTY.
1	2P001-D122M6-01065	Socket Head CAP Screw	A2-70 M6xP1.0x65	1
2	2C004-00055	Flat Box Assy	195x125x87	1
3	2P001-D1B2M5-0808	Socket Head CAP Screw	SUS316 M5xP0.8x8	4
4	2C004-00054	Stand Assy	K25 (2500W)	1
5	2D004-00077	Driver Stand Shim		1
6	2D004-00076	Driver Stand Locking Bolt	M12xP1.25x10L	1
7	2P001-D1B2M6-10012	Socket Head CAP Screw	A4-50 M6xP1.0x12	3
8	2C004-00057	Compensation Module	K25	1
9	2C004-00050	Housing Assy	W / KBMS-25X04-E00	1
10	2P001-K322M6-6-40	SS Parallel Key	6 x 6 x 40	1
11	2D004-00092	Gear Shaft Rotary Bush		1
12	2D004-00131	Constant Section Rings	ID18.8xW2.15x0.5t	1
13	2C004-00051	Seal Cap Assy		1
14	2D004-00074	Support Rod		3
15	2P001-D1B2M6-10016	Socket Head CAP Screw	A4-50 M6xP1.0x16	5
16	2D013-00015	Socket Head CAP Screw	SUS316 M5xP0.8x115	3
17	2D004-00070	Nozzle		1
18	2P005-SET0090	Vetus Propeller	BOW125/130/160 Propeller	1
19	2D004-00094	Propeller Hub		1
20	2P001-D1B2M10-15040	Socket Head CAP Screw	A4-50 M10x1.5Px40	1

DWTEK CO., LTD
 No. 22 Dong Ying Rd,
 Taichung City, Taiwan R.O.C
 Phone: 886 4 35024890
 Fax: 886 4 22112890
 E-mail: info@dwitek.com.tw

DWTEK

CATEGORY : Thruster DWT135D4
 PART No. 2B0040009-00001

Figure 28 - DWT135D4 Thruster (2B0040009-00001)

ITEM No.	PART No.	TITLE	DESCRIPTION	QTY.
1	2C004-00052	Motor shaft Assy	W / KBMS-25X04-E00	1
2	2D004-00087	Bush	φ6*3.9	2
3	2P001-V2B2M6-100	Self-Tapping Inserts - Slotted	SUS316 M6xP1.0	1
4	2C004-00089	Motor Stator Assy		1
5	2D004-00065	Pin Nut	M6	3
6	2P002-SOR-AS012N70	O-Ring	ID9.25 x W1.78	1
7	2D003-00016	Pressure relief valve	5/16" x T24	1

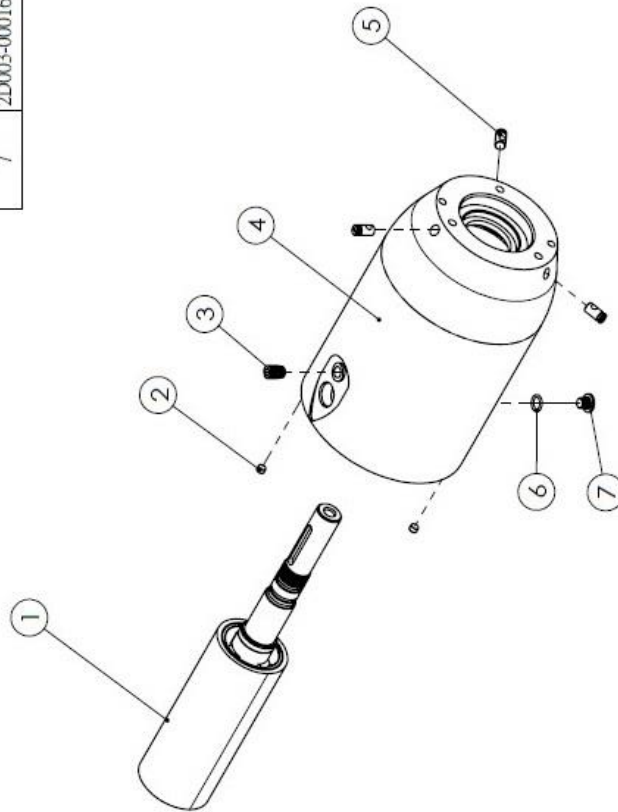

DWTEK CO., LTD
 No. 22 Dong Ying Rd,
 Taichung City, Taiwan R.O.C
 Phone: 886 4 35024890
 Fax: 886 4 22112890
 E-mail: info@dwtek.com.tw



CATEGORY : Housing Assy
 PART No. 2C004-00050

Figure 29 - Housing Assy (2C004-00050)

ITEM No.	PART No.	TITLE	DESCRIPTION	QTY.
1	2P001-D2B2M6-10012	Socket Button Head Cap Screw	A4-50 M6xP1.0x12	6
2	2D004-00073	Latch Nut		2
3	2D004-00071	Flat Box Lid	K 25x4 Thruster 135	1
4	2P002-SOR-AS163N70	O-Ring	ID152.7 x W2.62	1
5	2N004-00008	電子半成品	550V2500W、推進器、PSS35MC1FT、V2.0	1
6	2D004-00072	Flat Box		1
7	2D013-00010	PIN	Ø10 * 18 -M6	2
8	2D004-00069	Hollow Center		1
9	2D013-00012	PIN	Ø10 * 12 -M6	2
10	2P001-D1B2M6-10016	Socket Head CAP Screw	A4-50 M6xP1.0x16	2
11	2GMI70708M-00002	MSL-FCR接頭	Male 8 Pin x DC600V	1
12	2P001-D1B2M4-07016	Socket Head CAP Screw	SUS316 M4xP0.7x16	4
13	2P011-21SBAW10EVX	Parker quicky coupling	G 1/8	1
14	2P002-SOR-AS012N70	O-Ring	ID9.25 x W1.78	1
15	2D003-00016	Pressure relief valve	5/16"xT24	1
16	2D004-00088	Stop Plate		2

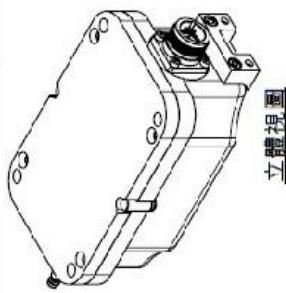
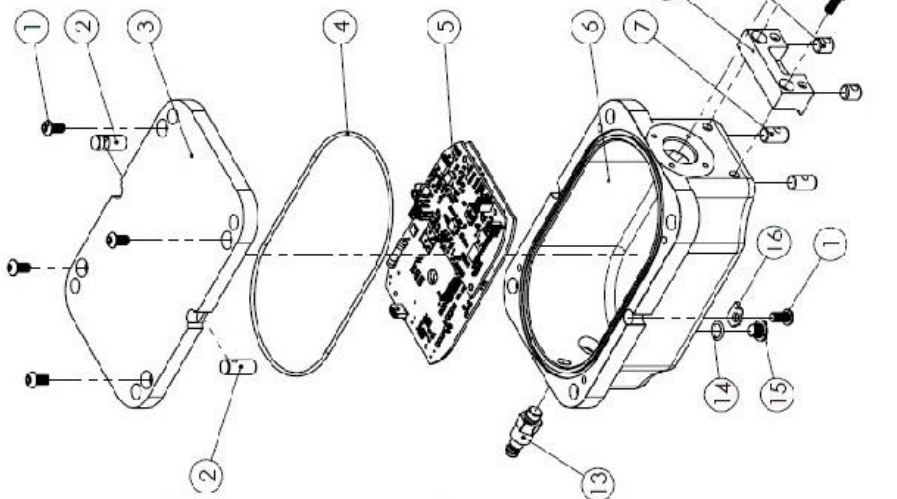

DWTEK CO., LTD
 No. 22 Dong Ying Rd.
 Taichung City, Taiwan R.O.C
 Phone: 886 4 35024890
 Fax: 886 4 22112890
 E-mail: info@dwitek.com.tw

DWTEK

CATEGORY : Flat Box Assy
 PART No. 2C004-00055

Figure 30 - Flat Box Assy (2C004-00055)

ITEM No.	PART No.	TITLE	DESCRIPTION	QTY.
1	2P001-AR5535	Circlip	R35	1
2	2P007-7202ZZKOYO	Ball Bearing	OD35xID15x11	1
3	2P001-WW5526	Wave Washer	WW-26 (26.4x34.2x3.5)	1
4	2D004-00091	Compensation Lid		1
5	2C004-00056	Comp Piston Assy		1
6	2D004-00090	Guiding block	OD70xID65x22.5	1
7	2C004-00079	Comp Piston	2500W	1
8	2P006-CM55-M9-S17	Wave Spring	Smalley CM55-M9-S17	1
9	2D004-00089	Compensation Cup		1

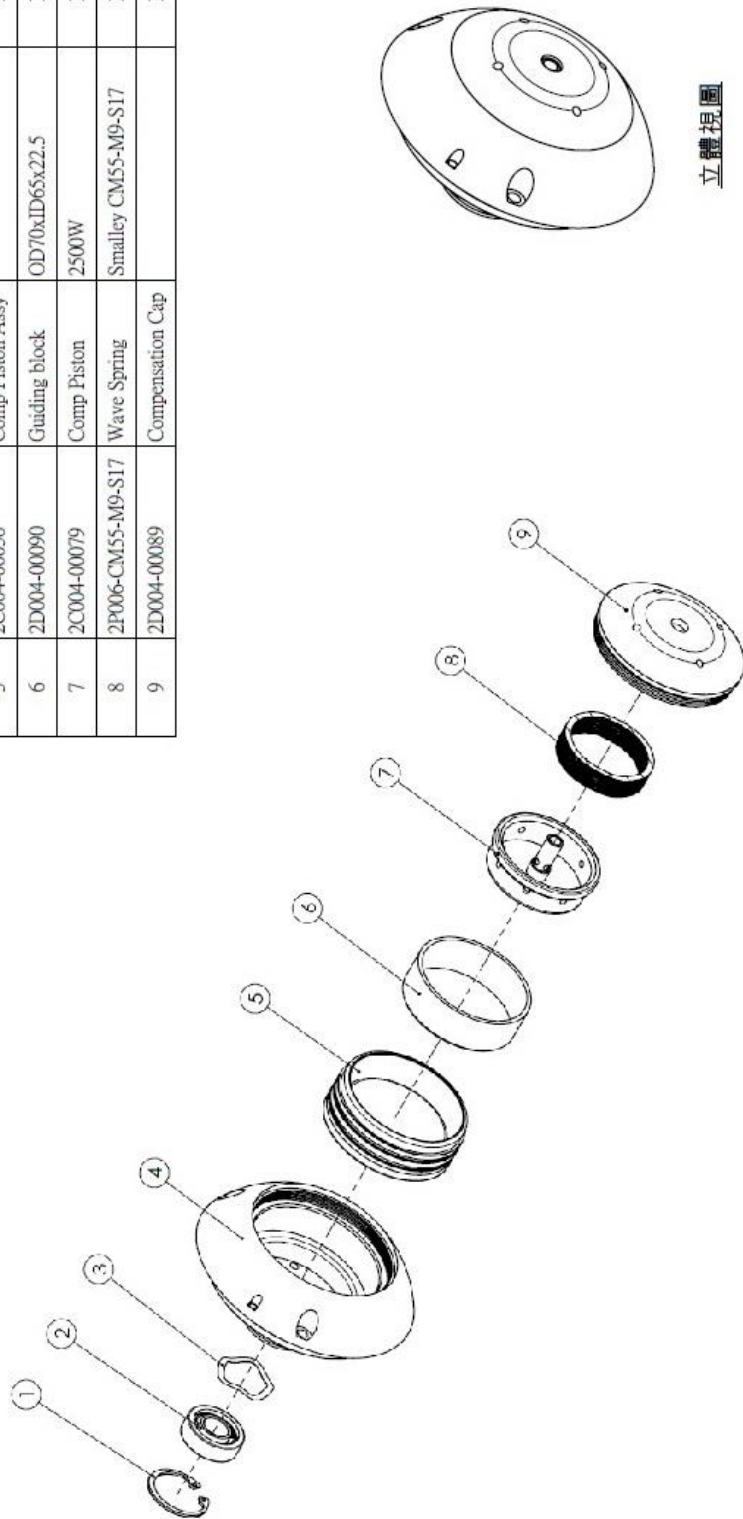

DWTEK CO., LTD
 No. 22 Dong Ying Rd.,
 Taichung City, Taiwan R.O.C
 Phone: 886 4 35024890
 Fax: 886 4 22112890
 E-mail: info@dwitek.com.tw

DWTEK

CATEGORY :
 Compensation Module
 PART No. 2C004-00057

Figure 31 - Compensation Module (2C004-00057)



The information contained in this document is subject to be modified and/or supplemented from time to time by DWTEK Co., Ltd without prior notice.

DWTEK Co., Ltd shall not be liable for any loss, errors or damage in connection with information in this document.

Copyright © 2023 DWTEK Co., Ltd. All rights reserved.