



Operator's Manual

DWT6537-300V Thruster

2T01-00037 2405

DWTEK Co., Ltd

No.22, Dong Ying Rd., East District, Taichung City 401, TAIWAN

T: +886-4-3502-4890 | E: info@dwtek.com.tw

F: +886-4-2211-2890 | W: www.dwtekmarine.com

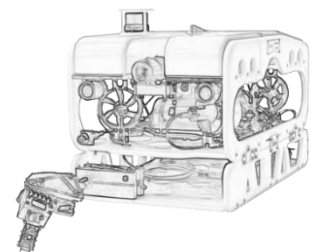



Revision information

Issue	Revisions	Date	Revised	Approver
1	First edition	2024/5/30	LIAO YU TSO	Mike Chen



Table of Contents

1	Introduction	6
1.1	General.....	6
1.2	Precautions	7
2	Specifications.....	8
2.1	Thruster	8
2.2	Connector.....	10
2.2.1	General.....	10
2.2.2	Indications for Replacement	10
2.2.3	Installation Procedures.....	10
3	Installation.....	11
3.1	Installation Guide.....	11
3.2	Pin Assignment	11
3.3	Maintenance and Removal.....	13
4	Trouble shooting	14
4.1	Thruster Trouble shooting	14
4.2	Detection Procedure.....	14
5	Maintenance.....	15
5.1	Nozzle	15
5.1.1	General.....	15
5.1.2	Indications for Replacement	15
5.1.3	Removal the Nozzle from Thruster	15
5.1.4	Installation Procedures.....	15
5.2	Propeller Assembly	16
5.2.1	General.....	16
5.2.2	Indications for Replacement	16
5.2.3	Removal Procedures	16
5.2.4	Install Procedures	16
5.3	Support Bearing	18
5.3.1	General.....	18
5.3.2	Indications for Replacement	18
5.3.3	Removal Procedures	18
5.3.4	Install Procedures	18
6	Appendix.....	19
6.1	Vacuum and Pressure Relief	19
6.2	Spares and Tools.....	20
6.3	Exploded View.....	21
6.4	PWM Signal Control	25



List of Figures

Figure 1 - DWT6537 Thruster	8
Figure 2 - DWT6537 Thruster Performance Curve	9
Figure 3 - Grease User Guide	10
Figure 4 - DWT6537 Thruster Pin Assignment	12
Figure 5 - Correct Fitting Type	17
Figure 6 - DWT6537 Thruster (2B0040002-00001)	21
Figure 7 - Rotating Propeller (2C004-00018).....	22
Figure 8 - Thruster Motor Assy (2C004-00033).....	23
Figure 9 - Shaft Reducer Assembly (2C004-00023).....	24
Figure 10 - The schematic diagram of the thruster PWM control	25



List of Tables

Table 1 - Precautions.....	7
Table 2 - DWT6537 Specification	8
Table 3 - DWT6537 Thruster Electrical	11
Table 4 - PWM Signal Control	11
Table 5 - Pin Assignment	11
Table 6 - Spares list.....	20
Table 7 - Tools list.....	20
Table 8 - PWM specifications.....	25



1 Introduction







1.1 General

DWTEK releases new range of brushless DC thrusters with the outstanding characters of low-weight, powerful thrust and integral electronic components. The engineering capabilities of DWTEK in subsea application drive our passion to innovate high reliable design and components to our thrusters.

DWT6537 thruster is a heavy-duty electric underwater thruster. The design is in purpose of high efficiency and low noise stealth; meanwhile it is suitable the propulsion system of any underwater robots or high-end surface utility vehicles.

1.2 Precautions

Table 1 - Precautions

	<p>The “DANGER” symbol indicates a hazardous situation which, if not avoided, will result in death or serious injury. Carefully read the message that follows to prevent serious injury or death.</p>
	<p>The “WARNING” symbol indicates a hazardous situation which, if not avoided, could result in death or serious injury. Carefully read the message that follows to prevent serious injury or death.</p>
	<p>The “CAUTION” symbol indicates a hazardous situation which, if not avoided, could result in minor or moderate injury, or equipment damage. Carefully read the message that follows to prevent minor or moderate injury.</p>
	<p>The “NOTICE” symbol alerts to a situation that is not related to personal injury but may cause equipment damage</p>
	<p>Do not put hands near it when machine operating.</p>
	<p>Do not wear electrically conductive jewelry, clothing, or other items while working on the electrical system.</p>
	<p>An electric shock could be fatal. Ensure power to the Thruster is OFF” before opening electrical panels.</p>

2 Specifications

2.1 Thruster

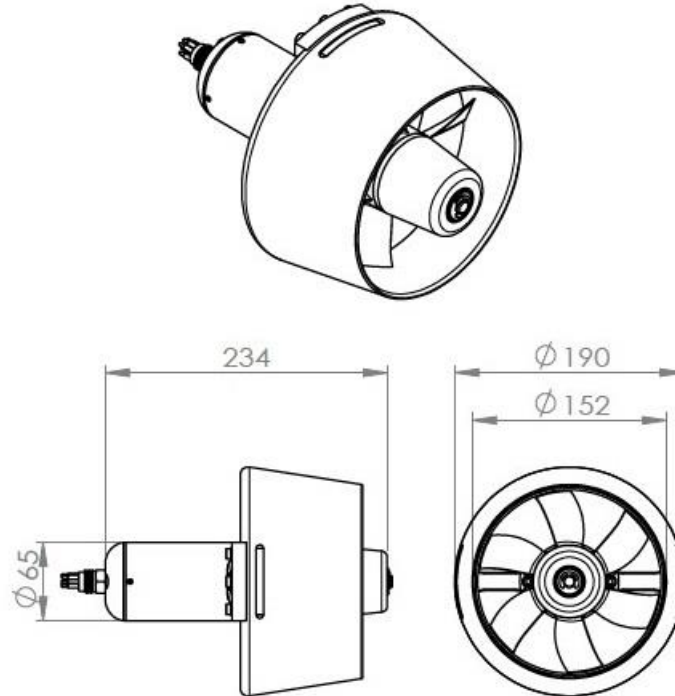
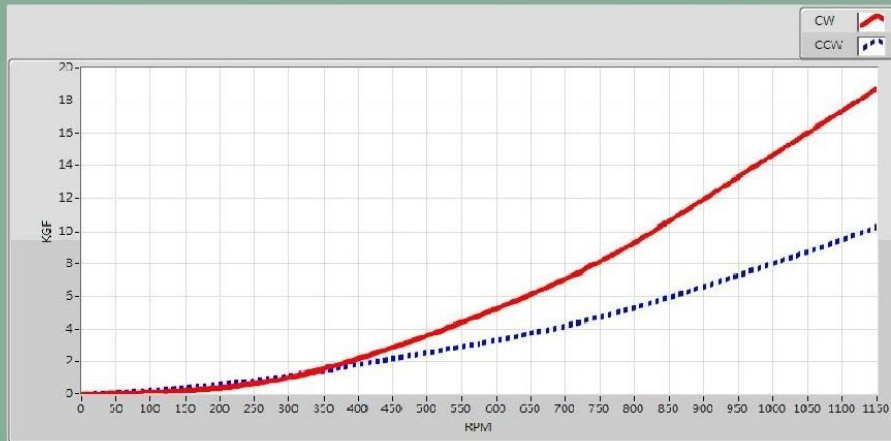

Figure 1 - DWT6537 Thruster

Table 2 - DWT6537 Specification

DWT6537	
MECHANICAL	
Weight in air	3.2 kg
Weight in water	1.9 kg
Standard Housing	AL 6061-T6
Propeller	Stainless
Nozzle	Nylon
ELECTRICAL	
Operation Voltage	300VDC
Speed Control	0-100% PWM Signal
Drive	Magnetically Coupling
Watt	750W
Protection	Over-Temp / Over Current / Under Voltage / Abnormal Operation
PERFORMANCE	
Thrust	CW: 17.5 kgf / CCW: 7 kgf

DWT6537-300V THRUST PERFORMANCE CURVES



RPM VS KGF

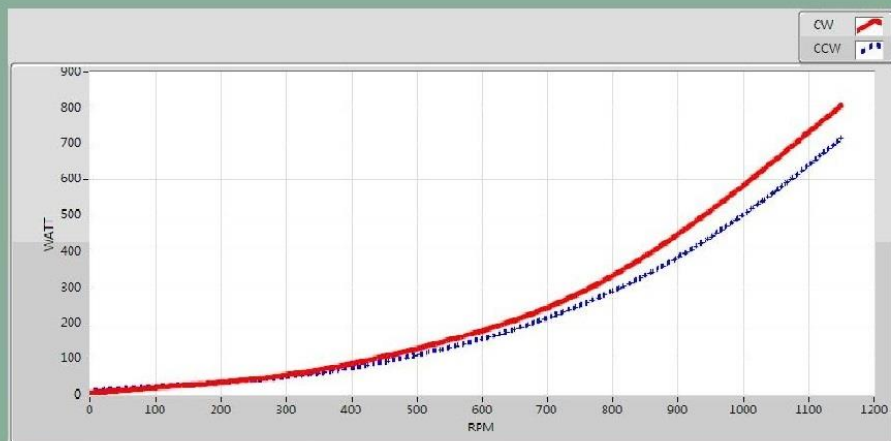

RPM VS WATT

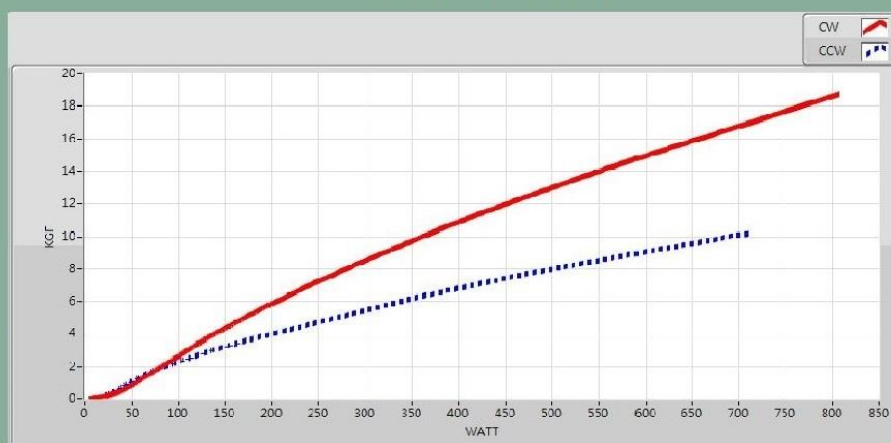

WATT VS KGF

Figure 2 - DWT6537 Thruster Performance Curve

2.2 Connector

2.2.1 General

Part No.	2GW100608M-00001
Title	Mini Bulkhead Connector Male 8 Pin
Service Check	Regularly

2.2.2 Indications for Replacement

Replace if connector is damaged, deformed or no longer watertight.

2.2.3 Installation Procedures

For greasing and mating above water

1. Connectors must be greased with Molykote 44 Medium before each mating.
2. A layer of grease corresponding to minimum 1/3 of socket depth should be applied to the female connector.
3. The inner edge of all sockets should be completely covered, and a thin transparent layer of grease should be left visible on the face of the connector.
4. After greasing, fully mate the male and female connector in order to secure optimal distribution of grease on pins and in sockets.
5. To confirm that grease has been sufficiently applied, de-mate and check for grease on each male pin, then re-mate the connector.

It is mandatory to apply GREASE before mating.

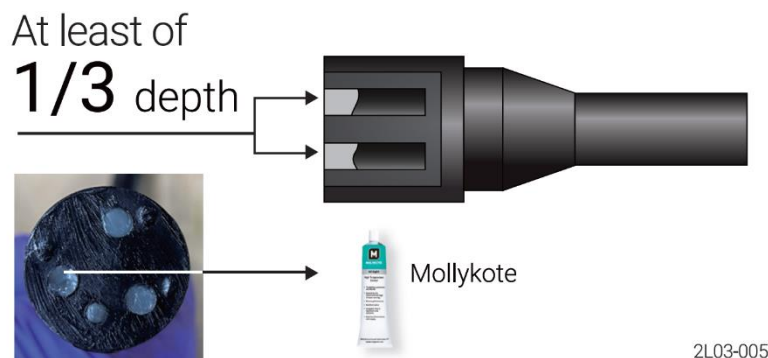

Figure 3 - Grease User Guide

For Cleaning

1. General cleaning and removal of any accumulated sand or mud on a connector should be performed with spray based contact cleaner, Isopropyl Alcohol.
2. New grease must be applied again before mating.



Warning!!

Only the qualified specialist is allowed to proceed the connector replacement.

3 Installation

3.1 Installation Guide

Table 3 - DWT6537 Thruster Electrical

	Nominal	Max	Min
Input Voltage	300 VDC	315 VDC	285 VDC
Input Current	2.50 A	2.38 A	2.63 A
Instrument Power Voltage	15 V	16.5 V	13.5 V
Instrument Power Current	0.08 A	0.07 A	0.09 A

Table 4 - PWM Signal Control

	Min	Nominal	Max
PWM Voltage	4.9V	5V	5.1V
PWM Frequency	1KHz	2KHz	10KHz
PWM Adjustment	5%	48%-52%	95%



*The PWM adjustment is about $\pm 2\%$ tolerance.

Procedure of electronic Connection:

- Step1. Connect Pin3 to +300 VDC
- Step2. Connect Pin1 to HGnd
- Step3. Connect Pin5 to PWM Signal
- Step4. Connect Pin7 to PWM Signal GND
- Step5. Connect Pin4 to +15 VDC (instrument)
- Step6. Connect Pin1 to HGnd (instrument 15 VDC)

3.2 Pin Assignment

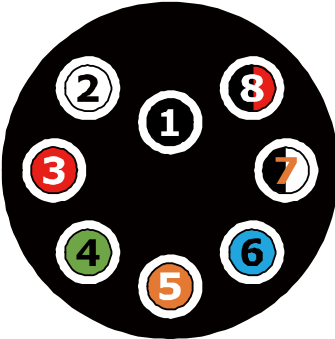
Table 5 - Pin Assignment

Female Inline Top View	Pin Assignment	Male Bulkhead Top View
	1 : HGnd 2 : PE 3 : +300 VDC 4 : +15 VDC 5 : PWM Signal 6 : N/A 7 : PWM Signal GND 8 : N/A	

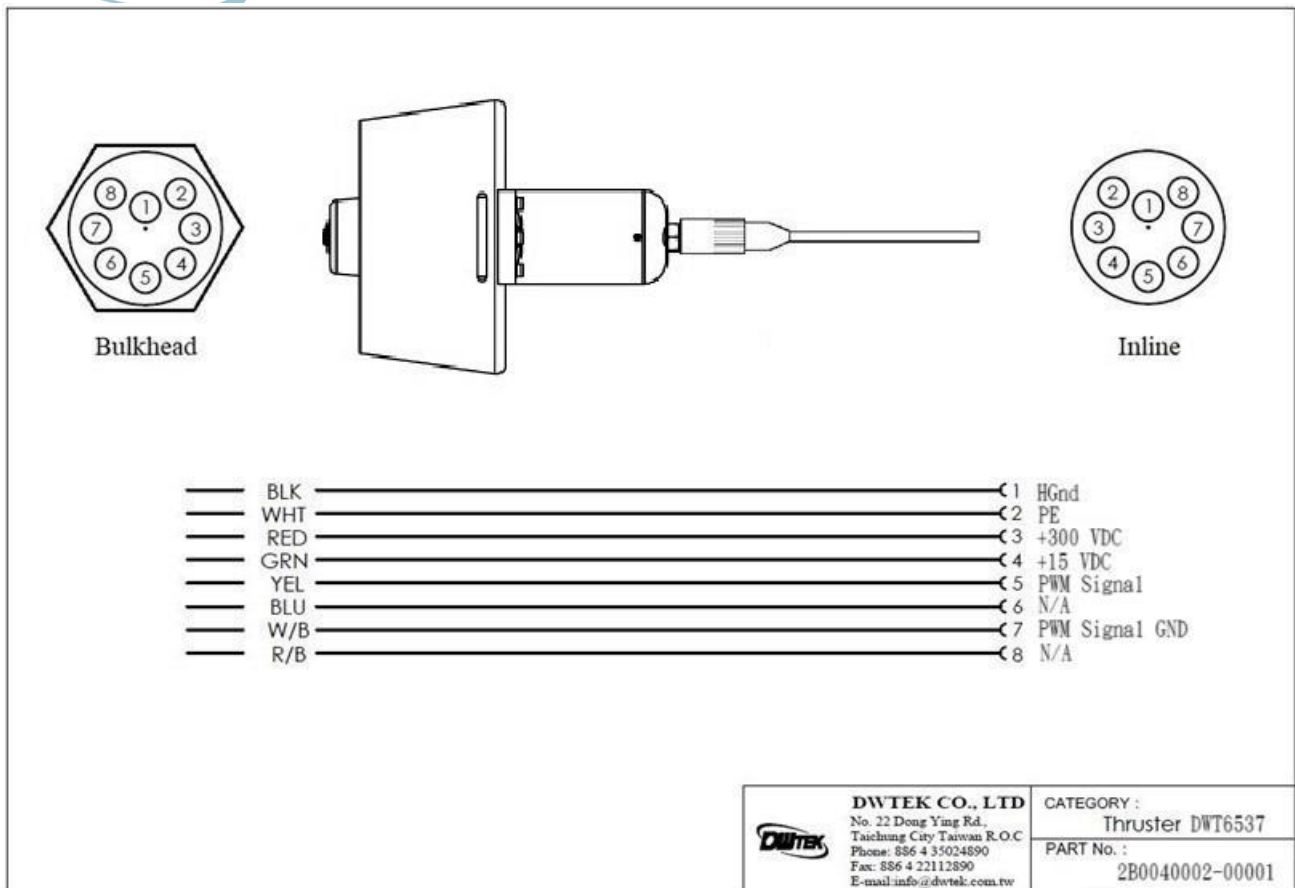

Figure 4 - DWT6537 Thruster Pin Assignment

Make sure all the connections are correct, and follow the instruction listed as below to power the thruster.

1. Connect Pin2 to the Protection Earth point
2. Deliver +15 VDC to Pin4 and Pin1
3. Deliver PWM control signal to Pin5 and Pin7
4. Make sure PWM control signal is set within 48%-52%
5. Deliver +300 VDC to Pin3 and Pin1
6. Adjust PWM control signal to pin5 and pin7
7. Thruster should turn CW and CCW according to the apply PWM signal

Note!!



1. Control signal is set as 0 RPM within PWM 48%-52%.
2. Always make sure to set the control signal within PWM 48%-52% before powering on +300Vdc to the thruster. Thruster will not be activated if control signal is out the range of PWM 48%-52% unless the control is set within PWM 48%-52%.
3. The CW maximum speed is set at 95% and the CCW maximum speed is set at 5%, to avoid the maximum speed caused by 0V or 5V when the wire is broken or shorted.
4. The WATT of DWT6537 at the maximum speed is about 750W±5%.
5. After the thruster powers on, DO NOT REMOVE the PWM control signal, otherwise the speed will be abnormal.



3.3 Maintenance and Removal

To remove the thruster, please follow below steps.

1. Disconnect the cable.
2. Install the protection dummy on the bulkhead connector

THRUSTER FIELD & DEPOT REPAIR PROCEDURES LISTED BELOW SHALL BE CARED.



Warning!!

Make sure to switch off thruster power and auto-functions once the system is on the surface.



Caution!!

It recommends considering the replacement of the O-rings and resealing DWT6537 thruster as annual maintenance. DWTEK offers comprehensive annual inspection and maintenance service to guarantee reliability and performance.



Caution!!

The thruster is designed as a simple maintenance unit. After each dive, please always wash with fresh water.

4 Trouble shooting

4.1 Thruster Trouble shooting

If thruster performed:

- I. RPM unsteady.
- II. Vibration.

please proceed the initial detection procedure which mainly caused by two type of cases as below:

- I. Power output.
- II. Consumption parts and determine the replacement.

4.2 Detection Procedure

1. Make sure the propeller is free of rotation and under safety and well protection.
2. Apply +15 VDC to Pin4 and HGnd to Pin1. It recommends using power supply with the current consumption indicator. The nominal current consumption is 0.08Amp +/- 0.02.
If current consumption is out of the above range without loading, the control PCB need to be examined and replaced.
3. Measure the analog input PWM signal with multimeter and make sure PWM signal is connected to Pin5 and Pin7 PWM Signal GND.
4. Apply input voltage +300 VDC to Pin3 and HGnd to Pin1.
5. Make sure PWM signal is within 48%-52% before delivering +300 VDC to thruster.
6. Use a current indicator to wire on the power supply in series before delivering +300 VDC.
7. Make sure current output is less than 0.1A when PWM control signal is 48%-52%.



Caution!!

If the current goes higher with short circuit, the power PCB need to be examined and replaced, please do not hesitate to contact DWTEK Co., Ltd.



5 Maintenance

5.1 Nozzle

5.1.1 General

Part No.	2D004-00047
Title	Nozzle
Service Check	Replace if damaged
Tool	1. 4mm Allen Key 2. Small flat screw driver

The nozzle is designed to improve the performance in water. Without the nozzle, there would be a drastic thrust reduction and control failure. Thruster can be tested in air but it recommends contacting DWTEK if doing enforced dummy load in the shaft of thruster.

The nozzle consists of a cast Nylon material that is high impact-resistant.

5.1.2 Indications for Replacement

Please replace the nozzle if it damages to the point that it fouls the propeller.

5.1.3 Removal the Nozzle from Thruster

1. Remove (6) Socket Head CAP Screw M5x20mm (P/N: 2P001-D1B2M5-08025) with 4mm Allen Key.
2. Remove (2) Wedges (P/N 2D004-00001) in the Nozzle with a small flat screw driver.

5.1.4 Installation Procedures

1. Install (2) Wedges (P/N 2D004-00001) in the slots of the Nozzle. Make sure to align the hole in the Nozzle and the screw holes in the wedges.
2. Put (6) Socket Head CAP Screw M5x20mm (P/N: 2P001-D1B2M5-08025) into the Nozzle screw hole.
3. Secure screws with 4mm Allen Key(4.2NM).



NOTE!!

If you have any further queries, please do not hesitate to contact DWTEK Co., Ltd.



5.2 Propeller Assembly

5.2.1 General

Part No. :	2C004-00018
Title :	Rotating Propeller
Service Check :	Before and after each dive
Tool	1. Flat Screw Driver 2. Flat Nose Piler

5.2.2 Indications for Replacement

Replace it if significant wear or damage is apparent on the blades of the propeller.

5.2.3 Removal Procedures

1. Remove E-clip (P/N 2P001-AE228) from the stem of the Rotor Hull Module (P/N 2C004-00022) by using a small screwdriver.
2. Remove Stopper Washer (P/N 2D004-00003) and Disc Spring (2P006-JTEM-10) with well storage.
3. Remove Propeller Assembly by pulling from exhaust end of Nozzle.

5.2.4 Install Procedures

1. Lightly lubricate the Support Bearing (P/N 2D004-00007) with Silicone grease (Dow Corning DC-4 or equivalent).
2. Insert the new Propeller Assembly into the open end of the Nozzle Assembly. Be sure to guide the inner Hub Sleeve Bearing over the stem of the rotor hull.
3. If the blades of the new Propeller Assembly interfere with the internal diameter of the Nozzle, use a file or coarse sandpaper to remove material from the ends of the blades. Remove materials sufficiently so the Propeller Assembly can rotate without interference while keeping tip clearance less than 1mm. If there are any concerns, please contact manufacturer.
4. Install Stopper Washer (P/N 2D004-00003) and Disc Spring (2P006-JTEM-10) on the stem of the Rotor Hull Module (P/N 2C004-00022).
5. Install E-clip(P/N 2P001-AE228) on the stem of the Rotor Hull Module (P/N 2C004-00022). Make sure E-clip fully engaged with the groove in the stem of Rotor Hull Module.



Figure 5 - Correct Fitting Type



Caution!!

Plastic disc washers act as elastic spaces to eliminate the gap and tolerances that appear during manufacturing or operation worn out.



Warning!!

Operator is only allowed to remove propeller assembly under power off condition.



NOTE!!

If you have any further queries, please do not hesitate to contact DWTEK Co., Ltd.

5.3 Support Bearing

5.3.1 General

Part No. :	2D004-00007
Title :	Support Bearing
Service Check :	Before and after each dive
Tool	1. Flat Screw Driver 2. Plug Gauge

Support Bearing is made from special high-performance plastic and is characterized by low coefficient of friction and high wear-resistance designed for dry and wet applications. The Support Bearing is used to stabilize the Propeller Assembly over the Rotor Hull.

Support Bearing allows the operator to do the replacement in the filed under the safe condition.

5.3.2 Indications for Replacement

1. Replace if excessive radial gap between the Propeller Sleeve Bearing and the Propeller Assembly exceeds 0.3 mm.

5.3.3 Removal Procedures

1. Remove the Propeller Assembly per Section 5.2 listed above.
2. Slide and remove the Support Bearing from the Rotor Hull by hand.

5.3.4 Install Procedures

1. Lightly lubricate the new Support Bearing with Silicone grease (Dow Corning DC-4 or equivalent).
2. Slide the Propeller Sleeve Bearing over the Rotor Hull and press into the guide pin of the Mounting Fixer (P/N 2C004-00014).
3. Reinstall the Propeller Assembly per Section 5.2 listed above.

NOTE!!



For the Support Bearing inspection, please regularly detect the gap by using Plug Gauge

NOTE!!



If you have any further queries, please do not hesitate to contact DWTEK Co., Ltd

6 Appendix

6.1 Vacuum and Pressure Relief

All electronic components could generate heat and prohibit system operation with a vacuum condition. Pressure relief port can be used as a vacuum port for testing purpose.

Recommended vacuum test on the pod is -80kPa for a period of 30 to 60 minutes after disassemble and re-assembly. It should be released once the testing is complete. Filling in Nitrogen gas from the Nitrogen bottle with an adaptor would take out the moisture to prevent concentration.

Warning!!



- 1. Make sure that this process was carried out in a well-organized place.**
- 2. Check and clean the O-rings on pressure relief valve before installation. If they are damaged, please replace it with new one, and greased with Molykote 44 Medium.**



6.2 Spares and Tools

Table 6 - Spares list

Item No.	Part No.	Description	Qty
1	2P006-JTEM-10	Od20 x Id10.2 x 1.1t Disc Spring	2pcs
2	2P001-AE228	ETW-8 E-Clip	1pcs
3	2P002-SOR-S29N70	ID28.5 x W2 O-Ring	1pcs
4	2P001-D1B2M5-08025	SUS316 M5xP0.8x25 Socket Head CAP Screw	6pcs
5	2P001-D4N0M4-0706	PEEK M4*P0.7*6 Socket Grub Screw	4pcs
6	2P002-SOR-S55N70	ID54.5 x W2 O-Ring	1pcs

Table 7 - Tools list

Item No.	Part No.	Description	Qty
1	2P001-FLU5M5	M5 Allen Key	1pcs

6.3 Exploded View

ITEM No.	PART No.	TITLE	DESCRIPTION	QTY.
1	2F001-D1B2M5-08025	Socket Head CAP Screw	SUS316 M5xP0.8x25	6
2	2F001-W4NWM5A	Washer	PE 5.2x10x1	6
3	2C004-00033	Thruster Motor Assy	For ROV (Top right)	1
4	2D004-00007	Support Bearing	φ 60x1000	1
5	2C004-00018	Rotating Propeller	Right / 750W	1
6	2F006-JTEM-10	Disc Spring	Od20 x Id10.2 x 1.1t	2
7	2D004-00003	Stopper Washer	SS φ 23x φ 10.1x3.5t	1
8	2F001-AE228	E型扣環	SUS304磨光8	1
9	2D004-00047	Nozzle	Blue	1
10	2D004-00001	Wedge		2

立體視圖

DWTEK CO., LTD
 No. 22 Dong Ying Rd.,
 Taichung City Taiwan R.O.C
 Phone: 886 4 35024890
 Fax: 886 4 22112890
 E-mail: info@dwitek.com.tw

DWTEK

CATEGORY : Thruster DWT6537
 PART No. : 2B0040002-00001

V1.0

Figure 6 - DWT6537 Thruster (2B0040002-00001)

ITEM No.	PART No.	TITLE	DESCRIPTION	QTY.
1	2D004-00012	Rotator Ring		1
2	2D004-00039	Right Rotating Propeller	DWP656P150R	1
3	2C004-00016	Magnetic Coupling	750W	1
4	2D004-00013	Propeller Hub		1
5	2C004-00004	Hub Bearing Module		1
6	2P007-BB-51100-B180-GL	Axial Grooved Ball Bearing	OD24xID10xH9	1
7	2D004-00014	Spiral retainer ring	ID21.6xOD25.4xW1.9x0.5t	1

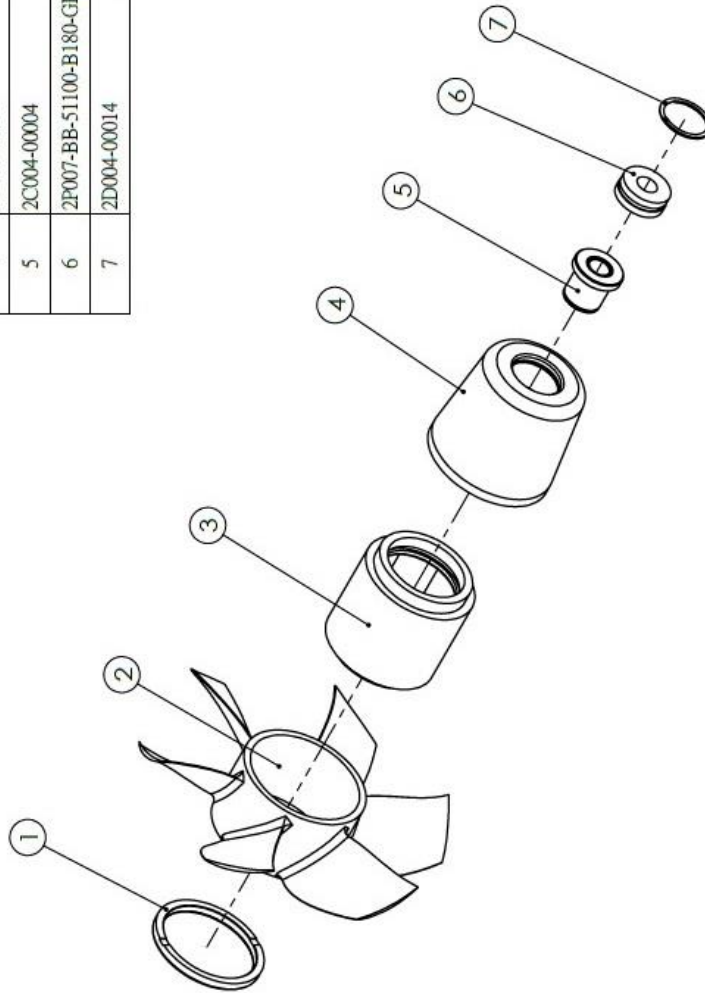

立體視圖

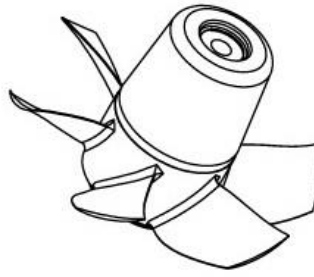

DWTEK CO., LTD
 No. 22 Dong Ying Rd.,
 Taichung City, Taiwan R.O.C
 Phone: 886 4 35024890
 Fax: 886 4 22112890
 E-mail: info@dwtek.com.tw

CATEGORY : Rotating Propeller
 PART No. : 2C004-00018

V1.0

Figure 7 - Rotating Propeller (2C004-00018)

ITEM No.	PART No.	TITLE	DESCRIPTION	QTY.
1	2GW100608M-00001	Mini Bulkhead Connector	Male 8 Pin	1
2	2D004-00008	Pressure relief valve	M6S07	1
3	2P002-SOR-S07N70	O Ring	ID6.5 x W1.5	2
4	2D004-00009	End Cap		1
5	2P002-SOR-S55N70	O Ring	ID54.5 x W2	1
6	2N004-00001			1
7	2P001-D4N0M4-0706	Socket Grub Screw	PEEK M4*P0.7*6	4
8	2C004-00038	Thruster Motor Assy	500W Thruster	1

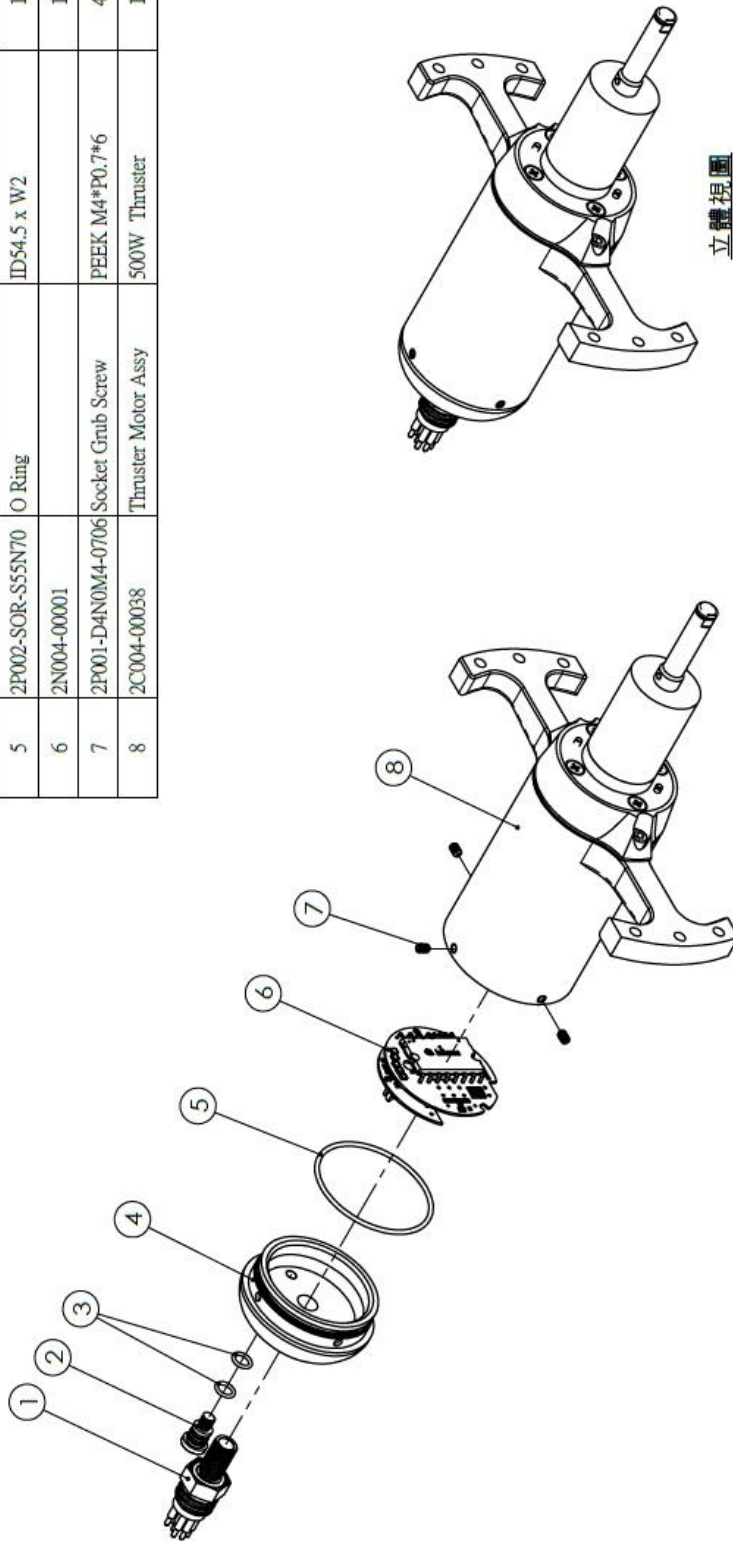

DWTEK CO., LTD
 No. 22 Dong Ying Rd.,
 Taichung City Taiwan R.O.C
 Phone: 886 4 35024890
 Fax: 886 4 22112890
 E-mail: info@dwtek.com.tw

DWTEK

CATEGORY :
 Thruster Motor Assy

PART No. :
 2C004-00033

V1.0

Figure 8 - Thruster Motor Assy (2C004-00033)

ITEM No.	PART No.	TITLE	DESCRIPTION	QTY.
1	2C004-00010	Shaft Reducer Assembly	w / 500W thruster	1
2	2P002-SOR-S29N70	O Ring	ID28.5 x W2	1
3	2C004-00015	Magnet Driver Rotor	φ 29.8x37	1
4	2P001-WT55M5	Serrated Safety Washers	M5x8.79x0.62	1
5	2P001-D1B2M5-08020	Socket Head CAP Screw	SUS316 M5xP0.8x20	1
6	2C004-00022	Rotor Hull Module	DWT6532	1
7	2C004-00014	Mounting Fixer	w / 500W/750W Thruster	1
8	2P001-PF22M4-0708	Cross Recessed Countersunk Head Screw	A2-70 M4xP0.7x8	4

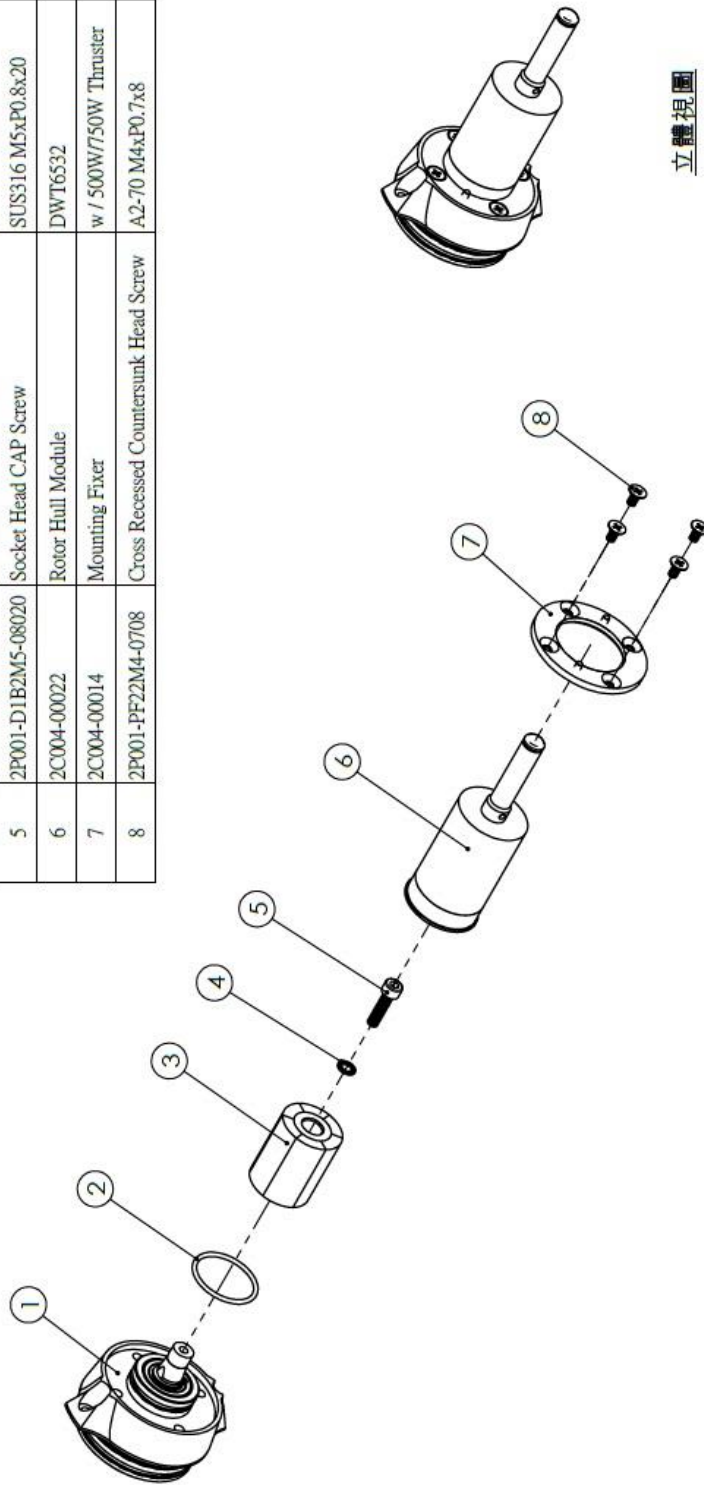

立體視圖

DWTEK CO., LTD
 No. 22 Dong Ying Rd.,
 Taichung City Taiwan R.O.C
 Phone: 886 4 35024890
 Fax: 886 4 22112890
 E-mail: info@dwitek.com.tw



CATEGORY :
 Shaft Reducer Assembly
 PART No. :
 2C004-00023

V1.0

Figure 9 - Shaft Reducer Assembly (2C004-00023)

6.4 PWM Signal Control

Table 8 - PWM specifications

	Min	Nominal	Max
Voltage	4.9V	5V	5.1V
Frequency	1KHz	2KHz	10KHz
Adjustment	5%	48%-52%	95%

*The PWM adjustment is about $\pm 2\%$ tolerance.

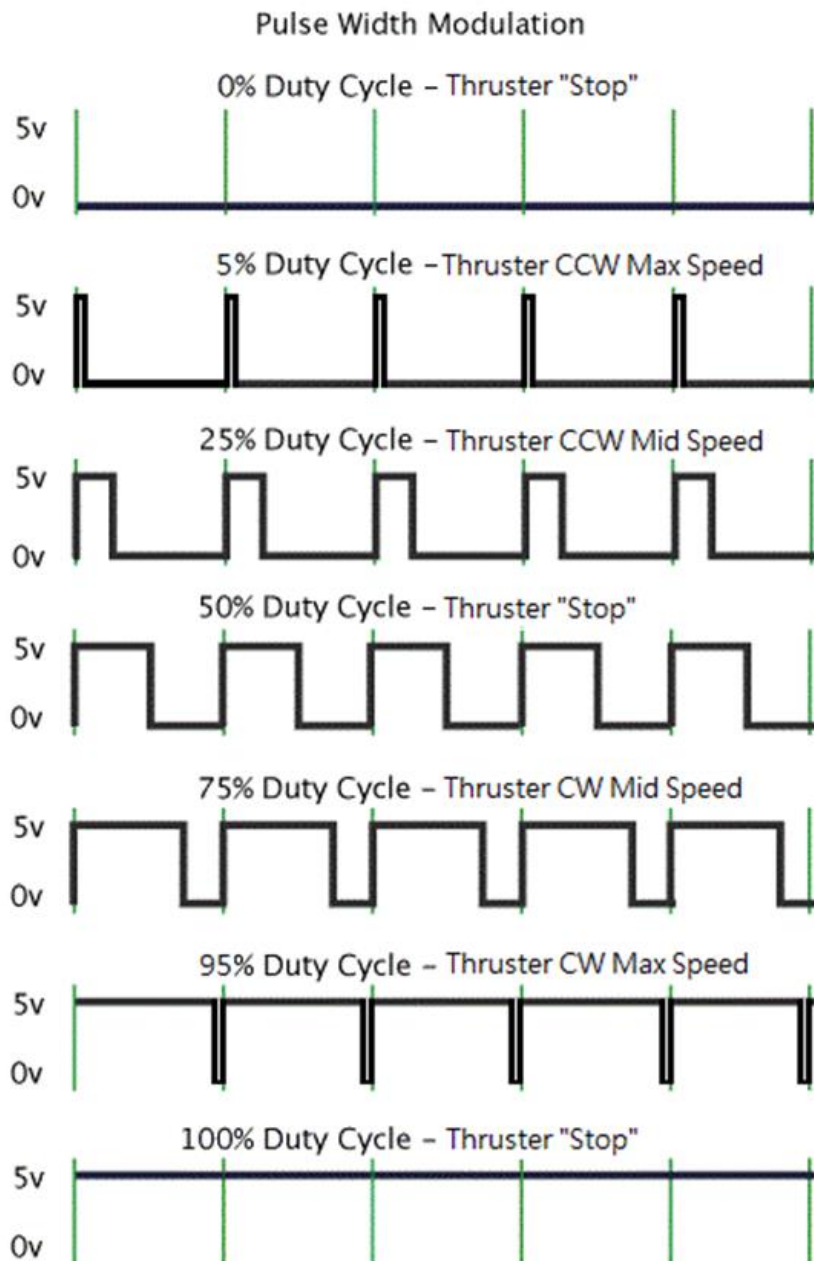

Figure 10 - The schematic diagram of the thruster PWM control

1. Thrusters are Clockwise from 53%-95%.
 - 53% are min speed Clockwise (CW)
 - 95% are max speed Clockwise (CW)
 2. Thruster is stopped at 48%-52%, 0%-5%, 95%-100%.
 3. Thrusters are Counter-Clockwise from 5%-47%.
 - 47% are min speed Counter-Clockwise (CCW)
 - 5% are max speed Counter-Clockwise (CCW)
- *The PWM adjustment is about $\pm 2\%$ tolerance.

Note!!



1. **Control signal is set as 0 RPM within PWM 48%-52%.**
2. **Always make sure to set the control signal within PWM 48%-52% before powering on +300Vdc to the thruster. Thruster will not be activated if control signal is out the range of PWM 48%-52% unless the control is set within PWM 48%-52%.**
3. **The CW maximum speed is set at 95% and the CCW maximum speed is set at 5%, to avoid the maximum speed caused by 0V or 5V when the wire is broken or shorted.**
4. **The WATT of DWT6537 at the maximum speed is about 750W $\pm 5\%$.**
5. **After the thruster powers on, DO NOT REMOVE the PWM control signal, otherwise the speed will be abnormal.**



The information contained in this document is subject to be modified and/or supplemented from time to time by DWTEK Co., Ltd without prior notice.

DWTEK Co., Ltd shall not be liable for any loss, errors or damage in connection with information in this document.

Copyright © 2023 DWTEK Co., Ltd. All rights reserved.